

Mothership

Year
2016

Tea table

Designer
András Kerékgártó



PLYDESIGN

Tea tables may entail many functions – a furniture piece representing a quiet corner with familiar and aesthetic objects such as a table lamp, a vase with fresh flowers or the favourite diary with thoughts and creative writings inside. The MOTHERSHIP tea table is an elegant pedestal for light supper servings, adapting to different kind of spaces due to its wide range of available shapes and sizes.

Dimensions:

Square table top size:
700 × 700 × 750 mm (L×W×H)
Weight: 13 kg

Round table top size:
Ø900 × 750 mm (D×H)
Weight: 15,5 kg

Order number:
Square table: 71000
Round table: 72000

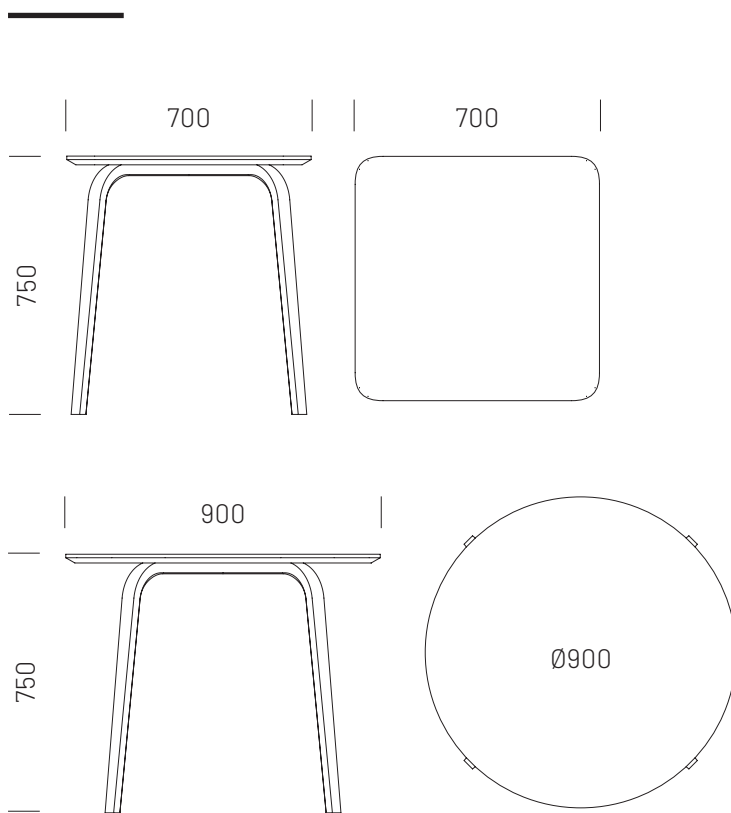







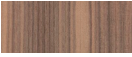

Certificates:

Stability and safety:
EN 12521:2016
EN 15372:2016



Surface resistance:
EN 12720:2009+A1:2013
SIS 83 91 17 2) or EN 15186 3)
EN 12722:2009+A1:2013
EN 12721:2009+A1:2013
NS 8061
EN ISO 105-E04:2013

MATERIALS & COLOUR OPTIONS

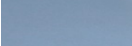
Shell and legs

	American walnut
	European oak
	Warm white
	Peach
	Claret
	Blue
	Green
	Gray
	Black
	Linoleum (tabletop only)





Upholstery – Fabrics

	Gray fabric
	Brown fabric

Upholstery – Leathers

	Brandy leather
	Brick leather
	Cognac leather
	Lava leather
	Navy leather
	Black leather

Base

	Chrome plated
	Black powder coated
	Polished aluminum
	Gray powder coated

Castors: black or chrome

Footrest

	Matte chrome
---	--------------

These are the standard range of materials and colours, customized options are available upon request.