

Korvet Jr.

Year
2019

Stool

Designer
András Kerégyártó



PLYDESIGN

KORVET family provides an elegant lift in any circumstances - barstools in two sizes guarantee the impeccable experience whether in a café, bar, or at the counter in a modern kitchen. The barstools can be customized with a chosen upholstery.

Dimensions:

426 × 420 × 620 mm (L × W × H)

Seat height: 450 mm

Seat width: 400 mm

Seat depth: 370 mm

Weight: 3,7 kg

Order number: 91000

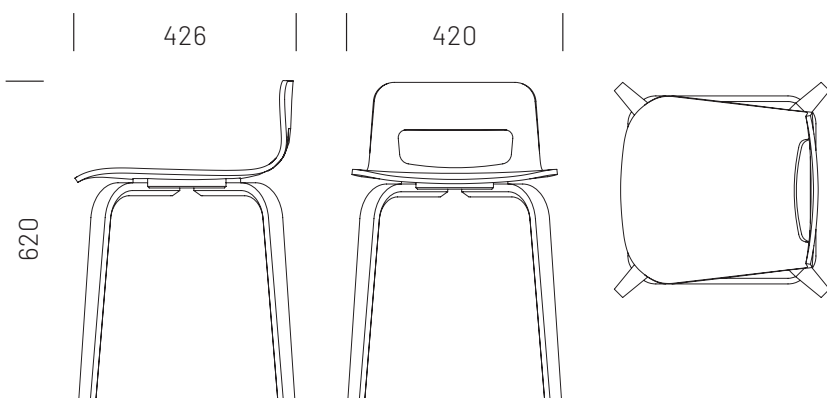







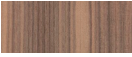

Certificates:

Stability and safety:
MSZ EN 12520:2016
MSZ EN 16139:2013



Surface resistance:
EN 12720:2009+A1:2013
SIS 83 91 17 2) or EN 15186 3)
EN 12722:2009+A1:2013
EN 12721:2009+A1:2013
NS 8061
EN ISO 105-E04:2013

MATERIALS & COLOUR OPTIONS

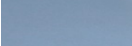
Shell and legs

	American walnut
	European oak
	Warm white
	Peach
	Claret
	Blue
	Green
	Gray
	Black
	Linoleum (tabletop only)





Upholstery – Fabrics

	Gray fabric
	Brown fabric

Upholstery – Leathers

	Brandy leather
	Brick leather
	Cognac leather
	Lava leather
	Navy leather
	Black leather

Base

	Chrome plated
	Black powder coated
	Polished aluminum
	Gray powder coated

Castors: black or chrome

Footrest

	Matte chrome
---	--------------

These are the standard range of materials and colours, customized options are available upon request.